

Cezar<sup>®</sup>

PERFECTION IN DETAILS

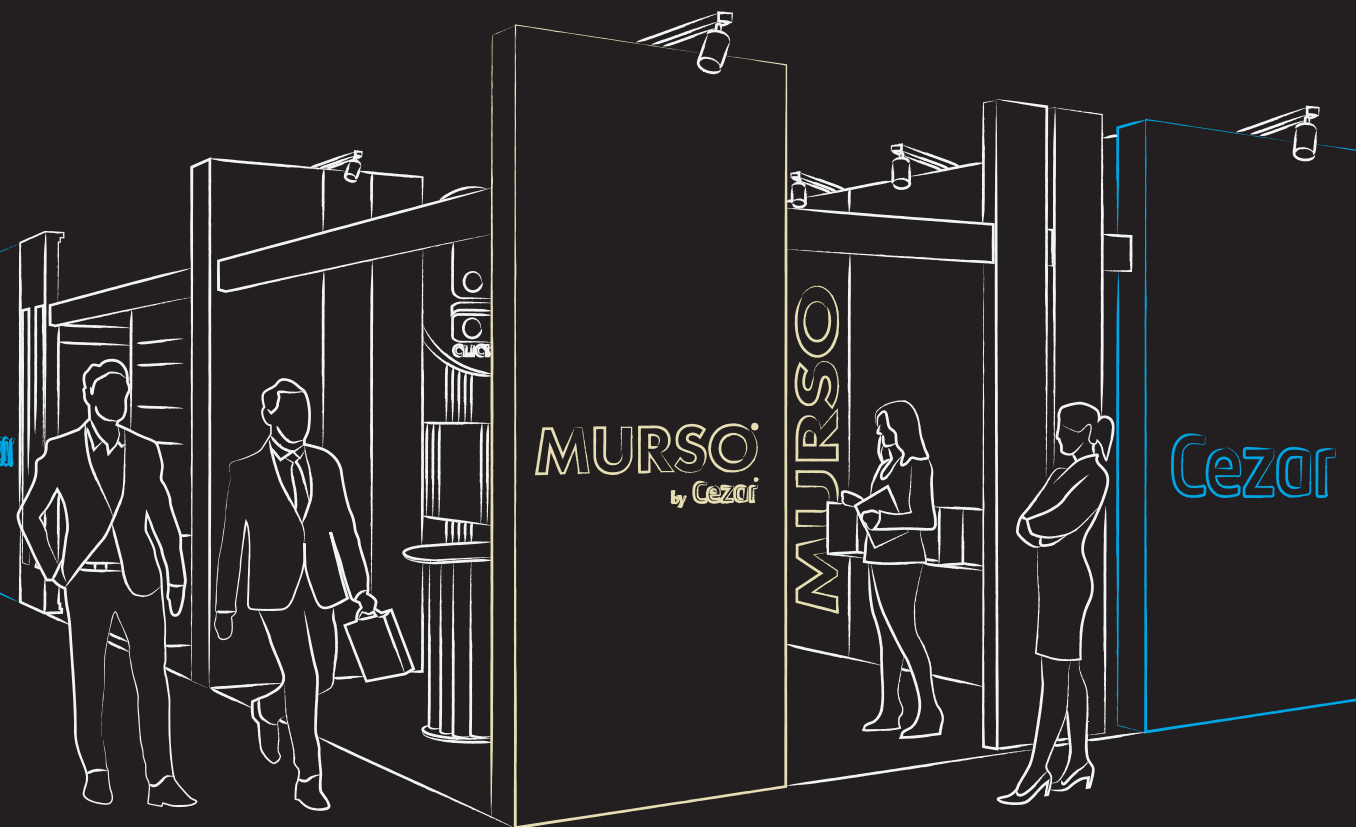



Cezary Niewiński

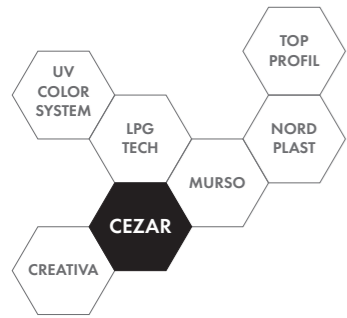

The CEZAR brand has been synonymous with the highest quality, pioneering innovations and timeless design since 1958. The founder of the company was a genius constructor Cezary Niewiński, whose enthusiasm and discoverer spirit can be found in the implemented projects. Today Cezar Group consists of 7 companies producing building materials and components for automotive industry.

PERFECTION IN DETAILS  
**1958**  
since



## design lab

CEZAR has always focused on innovation. Design Lab is a team of designers and constructors designing new products and methods of their production.



## 5 PLANTS IN THE CENTRE OF EUROPE

Factories located in independent locations ensure security in the event of random events.



**50**  
PRODUCTS AVAILABLE  
IN OVER 50 COUNTRIES

**12.500**  
PRODUCTS IN THE OFFER

**1.330**  
CUSTOMERS

**45**  
PRESENCE  
IN 45 DIY NETWORKS

**Q**  
QUALITY CONFIRMED  
BY CERTIFICATES



## logistics

A modern logistics center with an area of 8.500 m<sup>2</sup> guarantees efficient shipment of products. We carry out logistics in Europe with our own, modern transport fleet.

**36.000**  
(m<sup>2</sup>) TOTAL  
WAREHOUSE SPACE



We come from Elk, one of the cleanest regions in Europe. We feel responsible for the natural heritage and the future of the region. We create our products in accordance with the principles of sustainable development. Over the years, we have been improving the production process by increasing the amount of minerals in our products and increasing the use of recycled raw materials.

# SKIRTING BOARDS



## MASTER LINE® XPS

Foamed PVC skirting boards

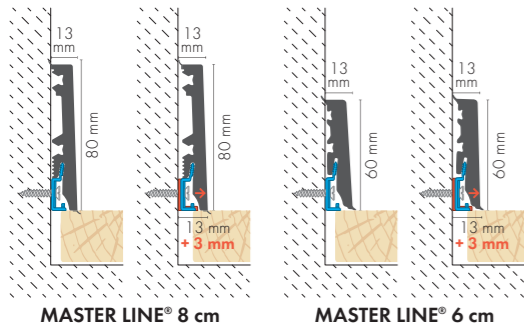

NEW MOUNTING CLIP WITH SPACER

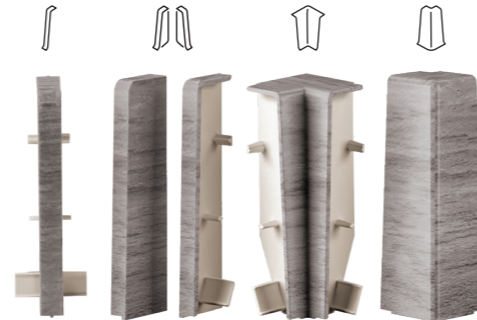

## MASTER LINE® 6 cm

Color	Code	Code	Code	Code	Code	Length
9003	829543	687716	687402	687723	601859	2.2 m
502	829505	688171	688140	688188	601804	2.2 m
256	829406	689284	689277	690006	601743	2.2 m
526	652981	687990	687907	688003	601828	2.2 m
528	829529	688119	688041	688126	601835	2.2 m
453	829499	680007	679209	685699	601798	2.2 m
520	829512	689253	812569	689260	601811	2.2 m
452	829482	679735	679193	685682	601781	2.2 m
435	829437	679230	679162	680472	601750	2.2 m
451	829475	679575	679186	681103	601774	2.2 m
436	829444	679483	679179	680502	601767	2.2 m
530	829536	687853	687761	687860	601842	2.2 m
354	810992	813085	812491	824531	811685	2.2 m
430	811173	836442	812590	832963	811760	2.2 m
355	811012	819094	812514	826818	811692	2.2 m

## MASTER LINE® 8 cm

Color	Code	Code	Code	Code	Code	Code	Length
9003	832208	822827	820793	834097	818424		2.2 m
456	609220	651977	651854	652103	609671		2.2 m
352	811470	820984	812750	836343	811791		2.2 m
476	609633	652066	651939	652189	622113		2.2 m
467	609428	652042	651915	652165	622038		2.2 m
468	609657	652080	651953	652202	635328		2.2 m
469	609626	652059	651922	652172	622069		2.2 m
353	811487	821059	812774	836350	812187		2.2 m
471	609411	652035	651908	652158	621994		2.2 m
430	811531	821097	812897	836381	812378		2.2 m
474	609664	652097	651960	652226	651830		2.2 m
475	609381	652011	651885	652134	620737		2.2 m
472	609299	651984	651861	652110	609688		2.2 m
470	609312	652004	651878	652127	609695		2.2 m
356	811517	821080	812873	836374	812361		2.2 m
355	811494	821073	812798	836367	812231		2.2 m
473	609640	652073	651946	652196	622182		2.2 m
9005	811418	820847	812699	836336	811784		2.2 m



Resistant to humidity - natural choice of floor finish, especially in bathrooms or halls.



Forget about silicone. Two flexible soft edges conform to wall and floor irregularities, sealing the connection.



The board installed with mounting clips can be removed with one move. After making corrections just put it back on.



Reliable durability - Master Line® is the expert in durability, that has been tested by many „small masters“.



Assembly on a clip



Assembly on a clip with spacer



Assembly on dowels

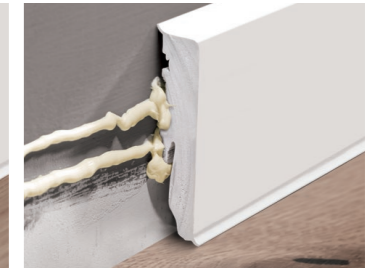

Assembly on glue

## ONE CONNECTOR - A LOT OF SOLUTIONS

Flexible connectors can be easily inserted into dedicated channels and join two boards.

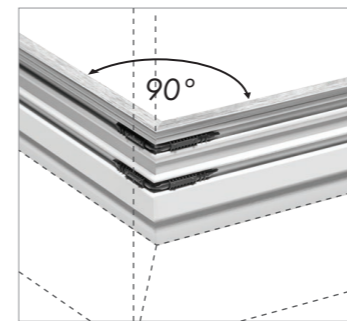

Internal corner

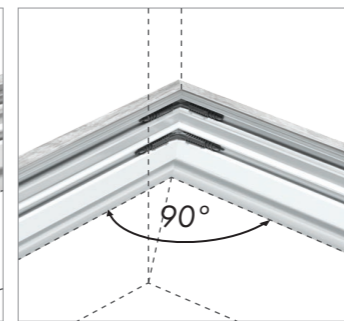

External corner

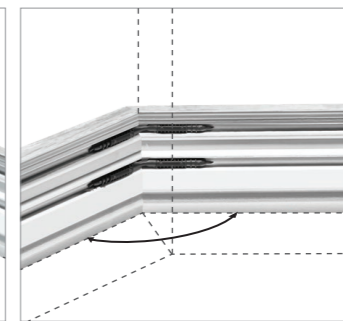

Connections at any angle



Connector

## MASTER LINE® 6 cm

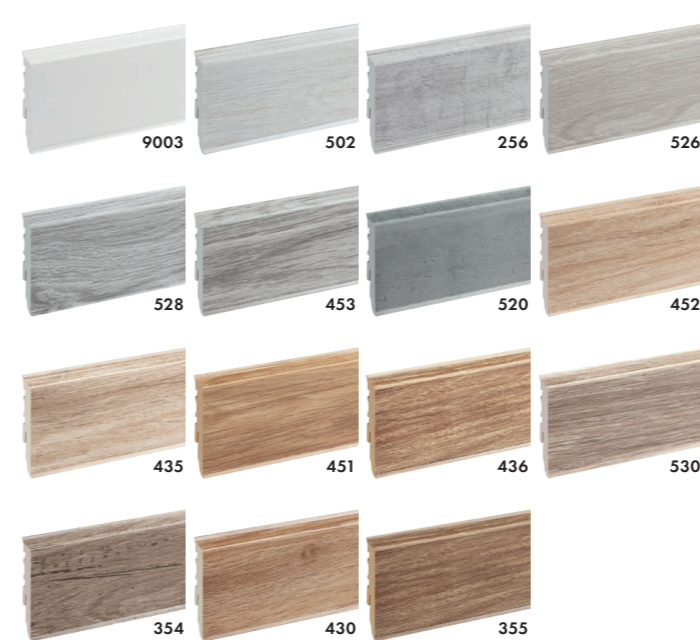

## MASTER LINE® 8 cm

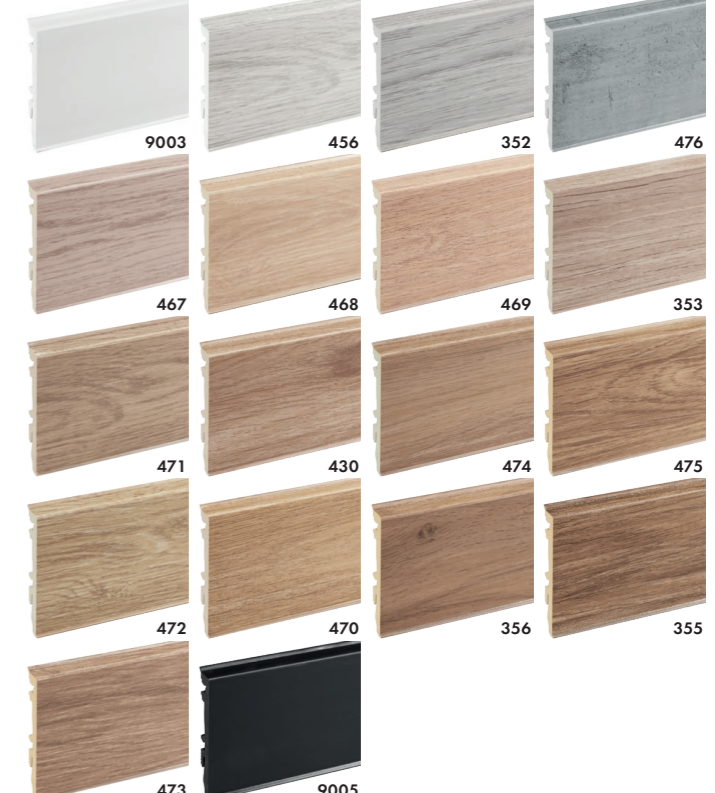

# SKIRTING BOARDS



## INTENSE XPS

Skirting boards

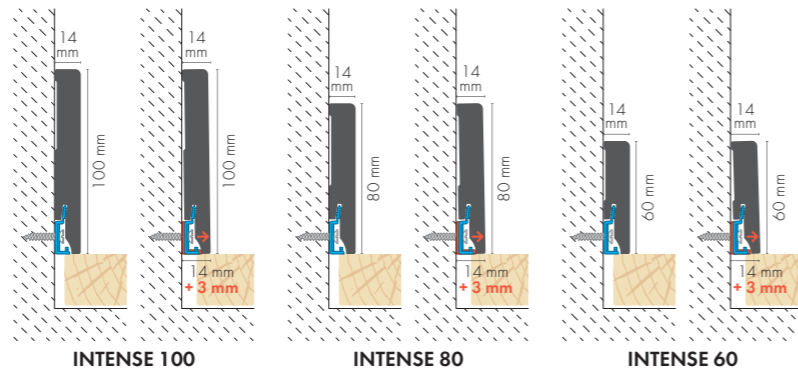

Skirting boards are available in two variants: white colour ready to install and prepared for painting in any colour.



Comfort of use in the rooms exposed to moisture.



The INTENSE® skirting boards are resistant to the scratches and bumps.

101	668364	2.44 m	
T101	668470	2.44 m	
T101	101	668500	2.44 m
T101	668692	2.44 m	
101	668708	2.44 m	
T101	668814	2.44 m	



Assembly on glue



Assembly on a clip



Assembly on a clip with spacer



NEW MOUNTING CLIP WITH SPACER



## TRIM FOR CARPETINGS PVC

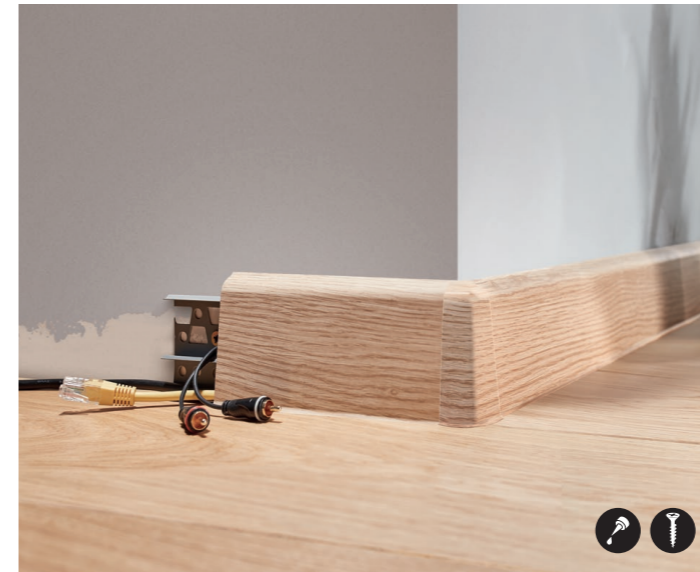
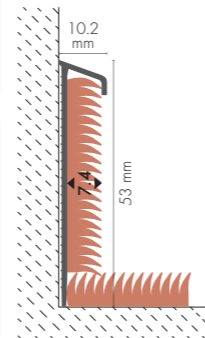
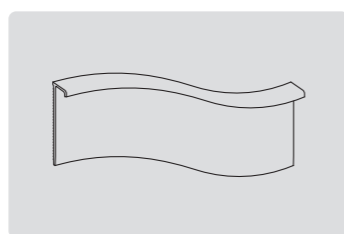
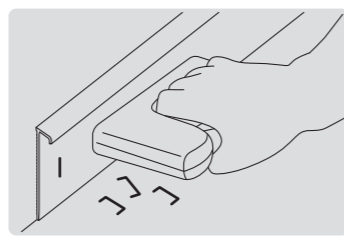

## SOFT LINE PVC

Skirting board

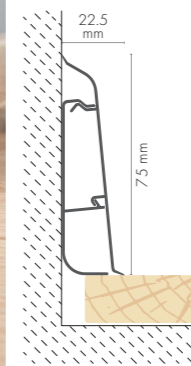

Resistant to humidity



Cables control



Two flexible soft edges conform to wall and floor irregularities, sealing the connection.



SOFT LINE® is a model of durability that you will appreciate in everyday use.



Assembly on screws



Assembly on glue

M078	818967	622045	622052	622083	622076	2.2 m
M106	818998	824425	824432	824449	824456	2.2 m
M135	818950	622144	622151	622168	622175	2.2 m
M163	818912	824470	824487	824494	824500	2.2 m
M200	819049	824524	824586	824593	824609	2.2 m
M236	818943	830235	830570	830587	828560	2.2 m
M253	818936	824623	824630	828140	828157	2.2 m
M256	818981	621987	622021	622014	622007	2.2 m
M289	819018	830723	830761	830730	830747	2.2 m
M290	818929	830778	830785	830792	830877	2.2 m
M301	818974	622090	622106	622137	622120	2.2 m
M319	819025	830679	830686	830693	830709	2.2 m
M423	819001	830891	830938	830945	830983	2.2 m
M089	806117	819056	819063	819100	819117	2.2 m
M088	819032	622199	824340	824395	824401	2.2 m
M090	811814	819216	819261	621963	621970	2.2 m

M078	M236		
M106	M253		
M135	M256	M301	M089
M163	M289	M319	M088
M200	M290	M423	M090

# SKIRTING BOARDS



## MDF Collection MDF

Skirting boards

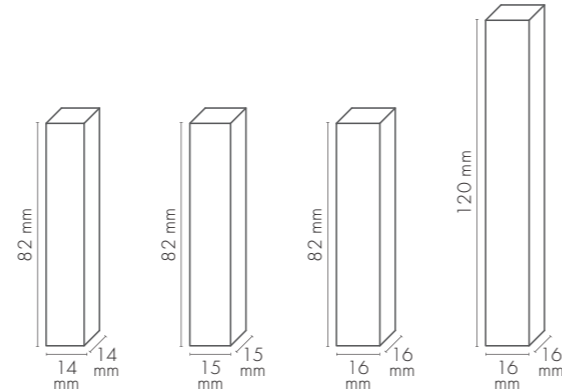

Assembly on a clip

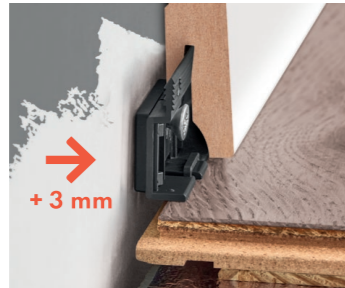

Assembly on a clip with spacer



Corners



Assembly on glue

Code	Color	Finish	Material	Width	Height	Length
838897	White	Lacquer	Semi-Matt	14 x 14 mm	82 mm	2
838903	White	Lacquer	High gloss	14 x 14 mm	82 mm	2
838941	White	Veneer	Semi-Matt	14 x 14 mm	82 mm	2
838958	Black	Lacquer	Semi-Matt	14 x 14 mm	82 mm	2
838965	White	Lacquer	Semi-Matt	15 x 15 mm	82 mm	2
838972	White	Lacquer	High gloss	15 x 15 mm	82 mm	2
838989	White	Veneer	Semi-Matt	15 x 15 mm	82 mm	2
838996	Black	Lacquer	Semi-Matt	15 x 15 mm	82 mm	2
839009	White	Lacquer	Semi-Matt	16 x 16 mm	82 mm	2
839016	White	Lacquer	High gloss	16 x 16 mm	82 mm	2
839023	White	Veneer	Semi-Matt	16 x 16 mm	82 mm	2
839030	Black	Lacquer	Semi-Matt	16 x 16 mm	82 mm	2
839047	White	Lacquer	Semi-Matt	16 x 16 mm	120 mm	2
839054	White	Lacquer	High gloss	16 x 16 mm	120 mm	2
839061	White	Veneer	Semi-Matt	16 x 16 mm	120 mm	2
839078	Black	Lacquer	Semi-Matt	16 x 16 mm	120 mm	2



### EXPERT MDF WOOD

Specialist assembly glue for elements made from MDF, wood, particle boards, OSB boards and cork. The glue is designated for use inside buildings.

Code	Volume	Quantity
839269	300 ml	15



## 58 x 14.5 mm

Code	Finish	Material	Length	Product Code	Quantity
9003	Lacquer	Semi-Matt	2.2 m	810466	10
9003	Lacquer	High gloss	2.2 m	810473	10
9005	Lacquer	Semi-Matt	2.2 m	810480	10
9005	Lacquer	High gloss	2.2 m	810497	10
9003	Veneer	Semi-Matt	2.2 m	810312	10



MOUNTING CLIP



MOUNTING CLIP WITH SPACER

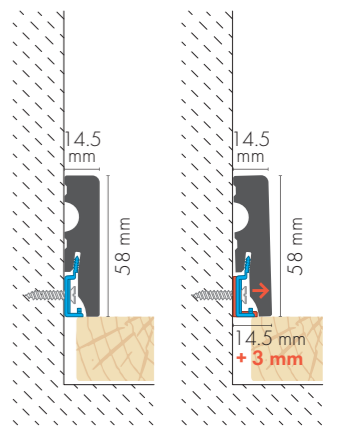

## 60 x 11 mm

Code	Finish	Material	Length	Product Code	Quantity
9003	Lacquer	Semi-Matt	2.2 m	810527	10
9003	Lacquer	High gloss	2.2 m	810534	10
9005	Lacquer	Semi-Matt	2.2 m	810541	10
9005	Lacquer	High gloss	2.2 m	810558	10
9003	Veneer	Semi-Matt	2.2 m	678622	10

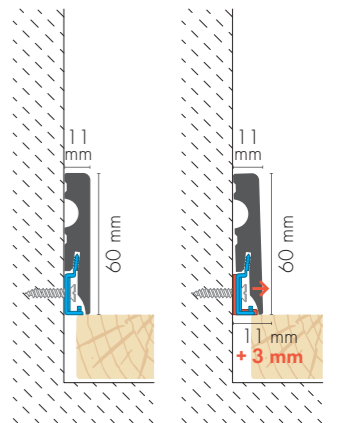

## 80 x 14.5 mm

Code	Finish	Material	Length	Product Code	Quantity
9003	Lacquer	Semi-Matt	2.2 m	810664	10
9003	Lacquer	High gloss	2.2 m	810688	10
9005	Lacquer	Semi-Matt	2.2 m	810695	10
9005	Lacquer	High gloss	2.2 m	810725	10
9003	Veneer	Semi-Matt	2.2 m	810350	10

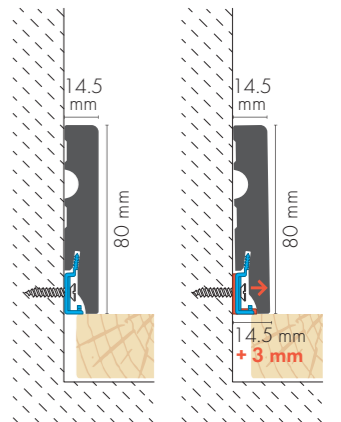

## 80 x 13 mm

Code	Finish	Material	Length	Product Code	Quantity
9003	Lacquer	Semi-Matt	2.2 m	810572	10
9003	Lacquer	High gloss	2.2 m	810589	10
9005	Lacquer	Semi-Matt	2.2 m	810596	10
9005	Lacquer	High gloss	2.2 m	810619	10
9003	Veneer	Semi-Matt	2.2 m	678639	10

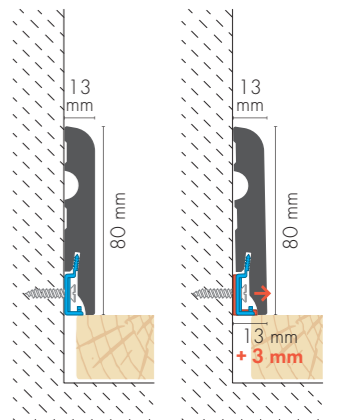

## SKIRTING BOARDS



### 100 x 16 mm

Code	Finish	Surface	Length (m)	Product No.	Quantity
9003	Lacquer	Semi-Matt	2.2	810855	10
9003	Lacquer	High gloss	2.2	810862	10
9005	Lacquer	Semi-Matt	2.2	810879	10
9005	Lacquer	High gloss	2.2	810886	10
9003	Veneer	Semi-Matt	2.2	810381	10



MOUNTING CLIP



MOUNTING CLIP WITH SPACER

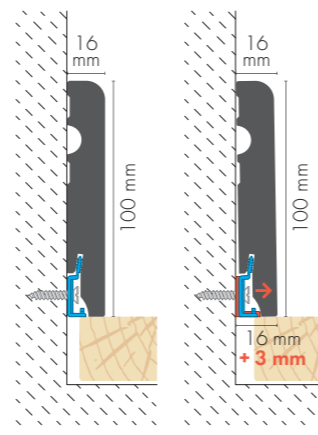

### 82 x 13 mm

Code	Finish	Surface	Length (m)	Product No.	Quantity
9003	Lacquer	Semi-Matt	2.2	810732	10
9003	Lacquer	High gloss	2.2	810749	10
9005	Lacquer	Semi-Matt	2.2	810756	10
9005	Lacquer	High gloss	2.2	810763	10
9003	Veneer	Semi-Matt	2.2	810411	10

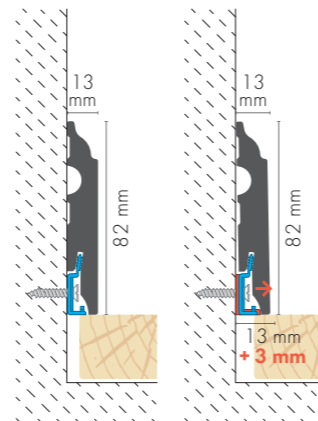

### 90 x 16 mm

Code	Finish	Surface	Length (m)	Product No.	Quantity
9003	Lacquer	Semi-Matt	2.2	810770	10
9003	Lacquer	High gloss	2.2	810787	10
9005	Lacquer	Semi-Matt	2.2	810794	10
9005	Lacquer	High gloss	2.2	810817	10
9003	Veneer	Semi-Matt	2.2	678660	10

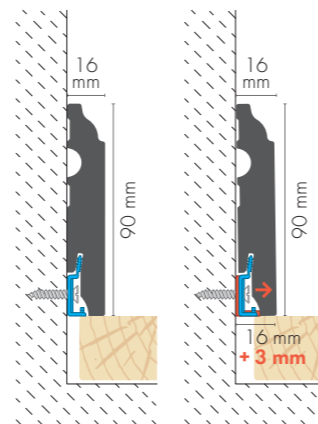

### 115 x 14.5 mm

Code	Finish	Surface	Length (m)	Product No.	Quantity
9003	Lacquer	Semi-Matt	2.2	810893	10
9003	Lacquer	High gloss	2.2	810923	10
9005	Lacquer	Semi-Matt	2.2	810930	10
9005	Lacquer	High gloss	2.2	810947	10
9003	Veneer	Semi-Matt	2.2	810459	10

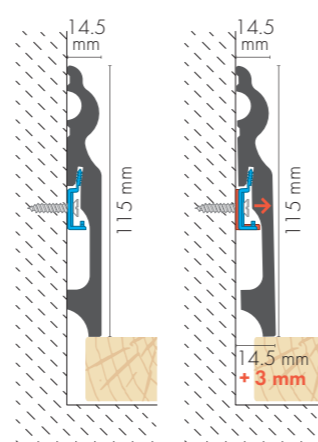

## UNDERLAYS

### PRO LVT Protect XPS

Underlay for LVT floors

1.1 mm

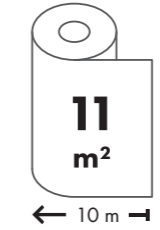
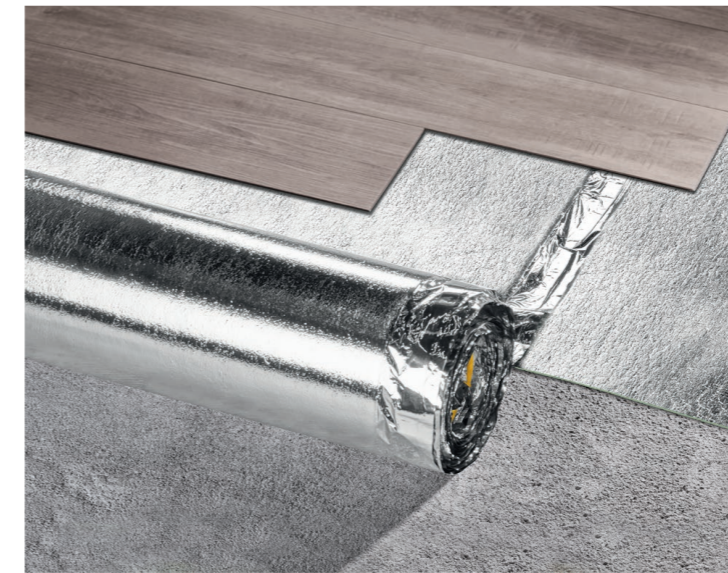

PRO fessional



CS (kPa)	200
IS (dB)	18
RWS (dB)	14%
PCv (mm)	0.5
TR (m² K/W)	0.62
RTF (E/E <sub>fl</sub> )	
For heated floor	

### EXPERT SYSTEM 3 XPS

Underlay with vapour barrier foil

2 mm

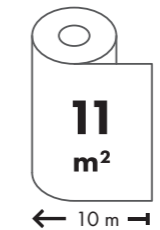

EXPERT



CS (kPa)	100
IS (dB)	18
RWS (dB)	14%
PCv (mm)	1.5
TR (m² K/W)	0.07
RTF (E/E <sub>fl</sub> )	
For heated floor	

# CONNECTION PROFILES

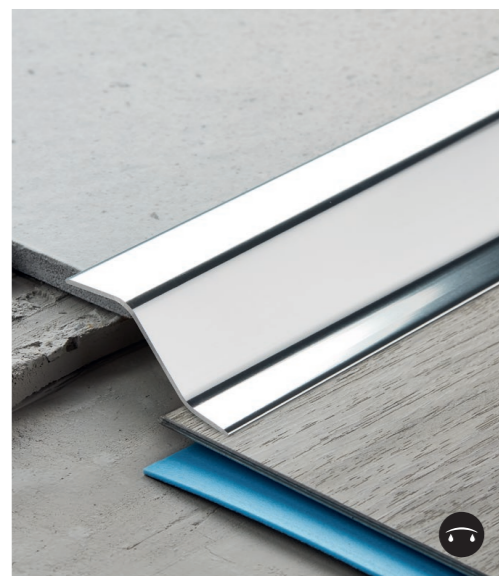

**LPZ30K/ LPZ40K/ LPZ50K** ALU

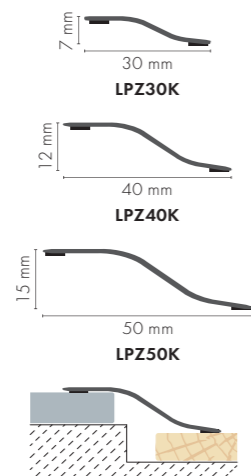

C51	829307
ECO	828690
EC0S	829291
C0	828683
C51	829345
ECO	829338
EC0S	829321
C0	828645
C51	828652
ECO	828669
EC0S	828676
EC23	829352



**LPOR100K** ALU

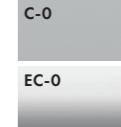
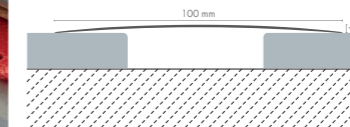

C0	828133
ECO	828164



**LPPG20K** PVC

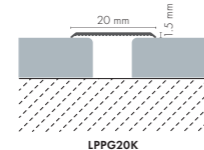

ECO	828614



**LWPO80** ALU

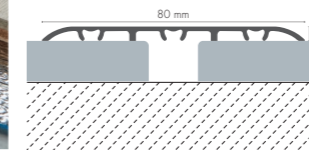

C0	826900
C0	826917
C23	826924
C23	826931
C32	826948
C32	826955
EC35S	826962
EC35S	826979

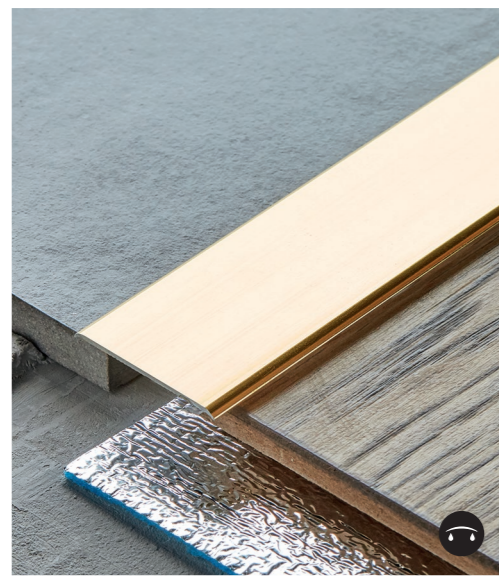

**LPPG30K** PVC

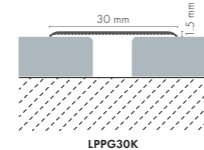

C0	825736
C51	828621
ECO	825729
EC0S	828638
EC23	825712



**LW30** PVC

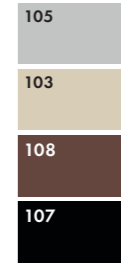
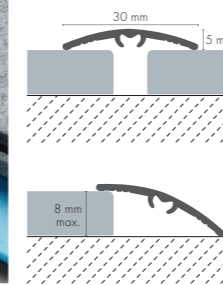

103	825804
105	826207
107	825804
108	826214

# CONNECTION PROFILES



**LW37C5W1** ALU

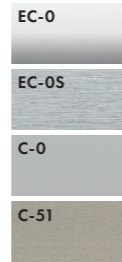
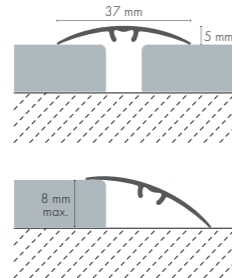

C0	825682
C51	828584
EC0	829376
EC0S	825675

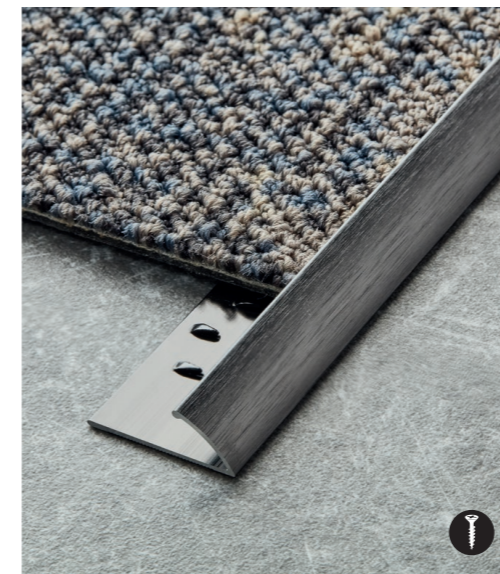

**DWZ10** ALU



C0	825330
C0	825347
C23	825354
C23	825361
C32	825378
C32	825385
EC0	825460
EC0	825408
EC0S	825415
EC0S	825422
EC35	825439
EC35	825446
EC35S	825453
EC35S	825392



**LW47C5W1** ALU

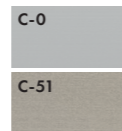
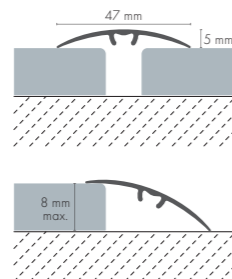

C0	825668
C51	828515

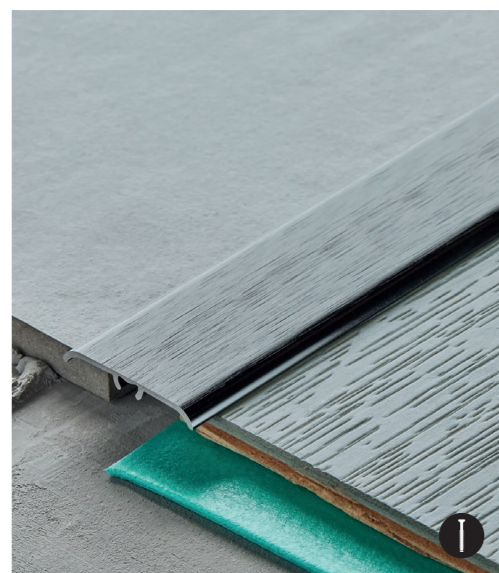

**LWPO35** ALU

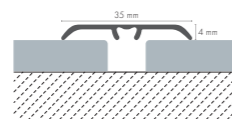

C0	828041
C0	826832
C23	828058
C23	826849
C32	828065
C32	826856
EC0	828072
EC0	826863
EC0S	828089
EC0S	826870
EC35	828096
EC35	826887
EC35S	828102
EC35S	826894



# STAIRS/ CONNECTION PROFILES



**FG14/ FG20** ALU

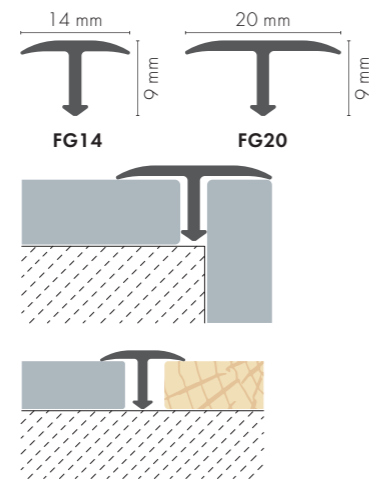

- C35S
- EC35
- EC35S

Code	Product Code
C35S	826542
C35S	826535
EC35	826528
EC35	826511
EC35S	826504
EC35S	826498
C35S	826481
C35S	826474
EC35	826467
EC35	826450
EC35S	826443
EC35S	826436



**D08/ D10/ D12** ALU

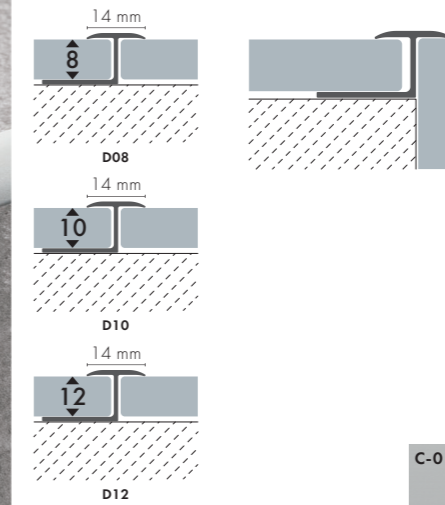

- C-0

Code	Product Code
ZC0	821813
ZC0	829154
ZC0	829178



**T13/ T18/ T26** ALU

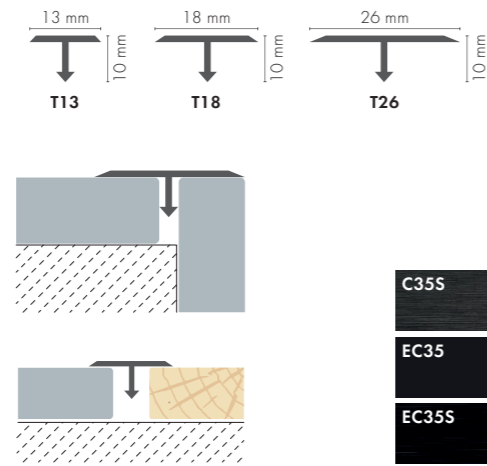

- C35S
- EC35
- EC35S

Code	Product Code
C35S	826252
C35S	826269
EC35	826276
EC35	826283
EC35S	826290
EC35S	826306
C35S	826313
C35S	826320
EC35	826337
EC35	826344
EC35S	826351
EC35S	826368
C35S	826375
C35S	826382
EC35	826399
EC35	826405
EC35S	826412
EC35S	826429

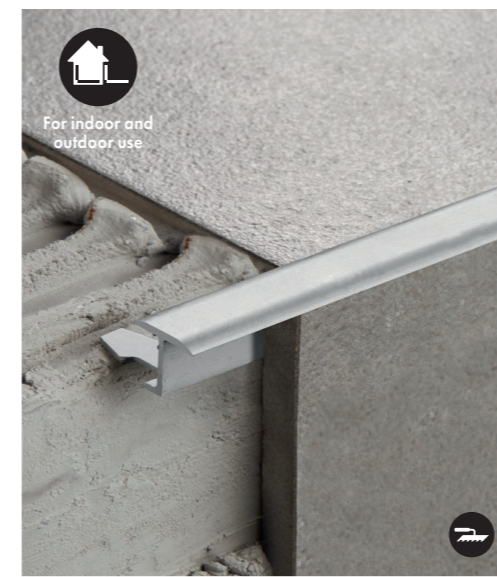

**D08P/ D10P/ D12P** ALU

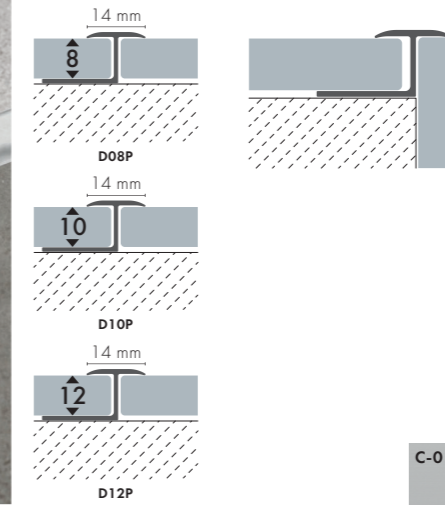

- C-0

Code	Product Code
ZC0	821837
ZC0	829161
ZC0	829185



**SKOS** ALU

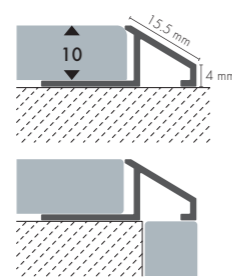

- C-0

Code	Product Code
ZC0	829123
ZC0	829130



**SKOSR** ALU

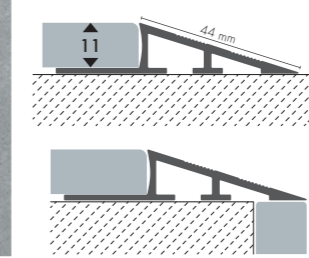

- C-0

Code	Product Code
ZC0	829147

# STAIRS/ FOR TILES PROFILES



**ZW10/ ZW12** ALU

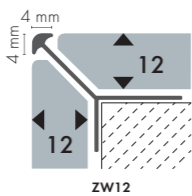
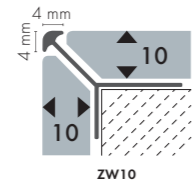

ECO	821653
C23	821677



**L10** ALU  
**L10ST** ST

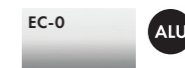
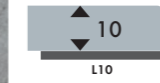

ECO	800467

SZ	819766

--	--

113M	825088
113P	825095
C0	825101
C23	825118
C32	825125
ECO	825132
EC0S	825149
113M	825156
113P	825163
C0	825170
C23	825187
C32	825194
ECO	825200
EC0S	825217
113M	825224
113P	825231
C0	825248
C23	825255
C32	825262
ECO	825279
EC0S	825286



**O12.5** ST

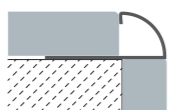

SZ	820281



**LK08/ LK10/ LK12** ALU

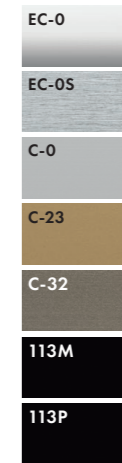
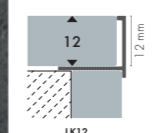
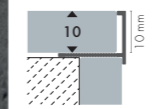
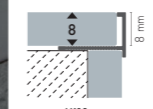

**PKK1008/ PKK1112** ALU

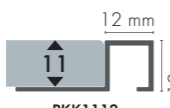
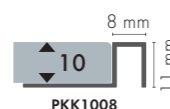

ECO	821585
ECO	821592

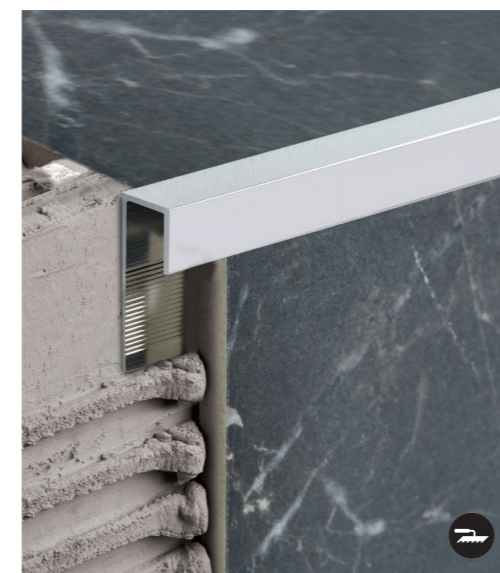

**PWP** ALU

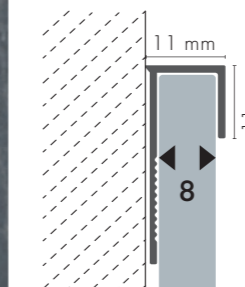

C0	825514
C32	825521
113	825507

# STAIRS PROFILES

**CL ALU**

For indoor and outdoor use



ZCO 829208



C-0

**ZET/ ZET12 ALU**

For indoor and outdoor use



ZCO 829390  
ZCO 829383

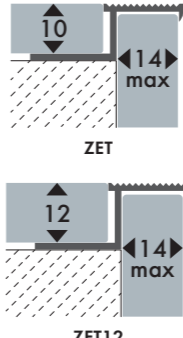

C-0

**PSP/ PSP12 ALU**

For indoor and outdoor use



ZCO 829215  
ZCO 829222

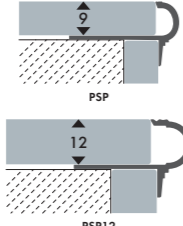

C-0

**PODKZG ALU**

For indoor and outdoor use



N 826801

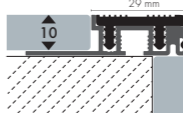

N

**ZETOW/ ZETOW12 ALU**

For indoor and outdoor use



ZCO 829239  
ZCO 829246



C-0

**OKAP ALU**

For indoor and outdoor use

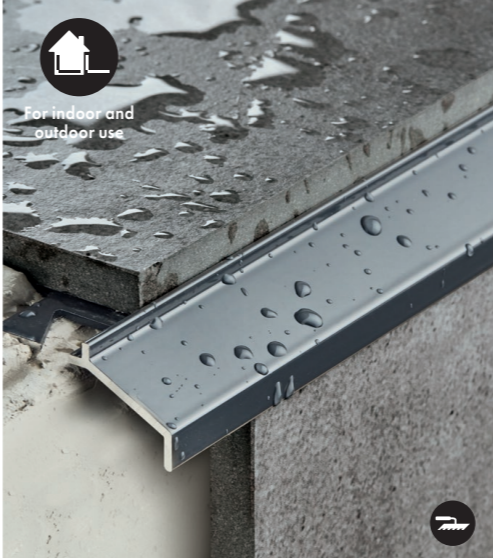

ZCO 829192

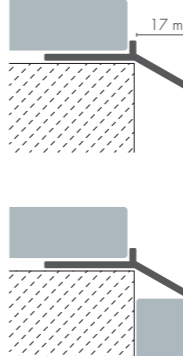

C-0

# STAIRS PROFILES

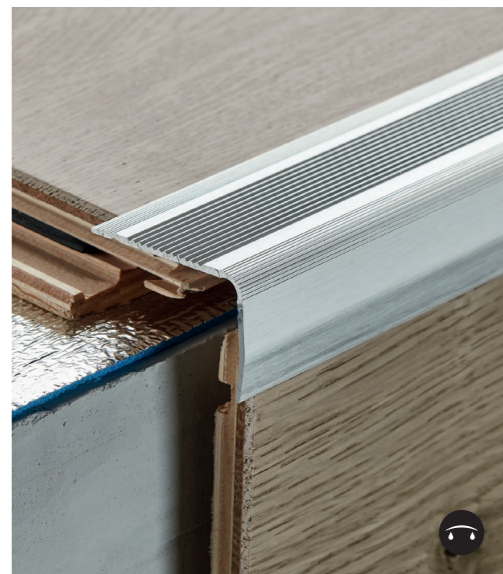

**LSR36K** ALU

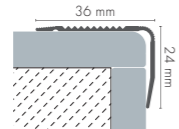

	843...
C0	825699
C51	829260
EC0S	829253



**LSR24/ LSR24K** ALU

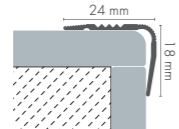

	843...
C0	825705
C51	828706
C51	829284
EC0S	828713
EC0S	829277

# PROFILES FOR TILES



**DOW10/ DOW20** ALU

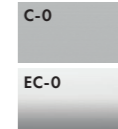
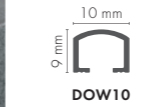

	843...
C0	825293
EC0	825309
C0	825316
EC0	825323



**U10** ST



	843...
PZ	832895
PS	832888

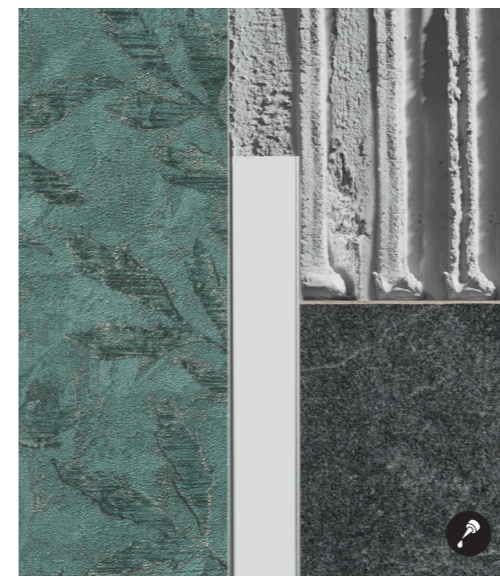

**U20** ST



	843...
PZ	832949
PS	832901

## DILATATION PROFILES



**DYW10** PVC  
Narrow dilatation profile

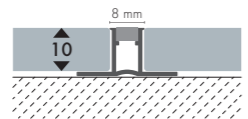

7046

7046	829116



**DYS85** PVC  
Arrow dilatation

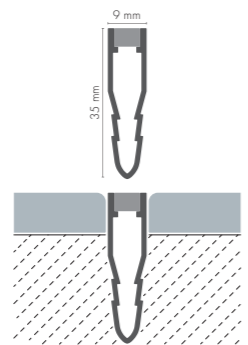

7046

7046	829109



**DY10G/ DY12G** ALU  
Dilatation with black rubber

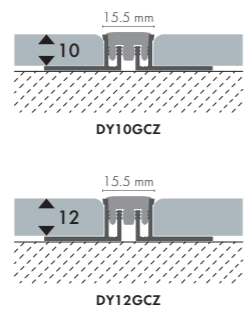

N

N	826788
N	826795

## BATHTUB PROFILES

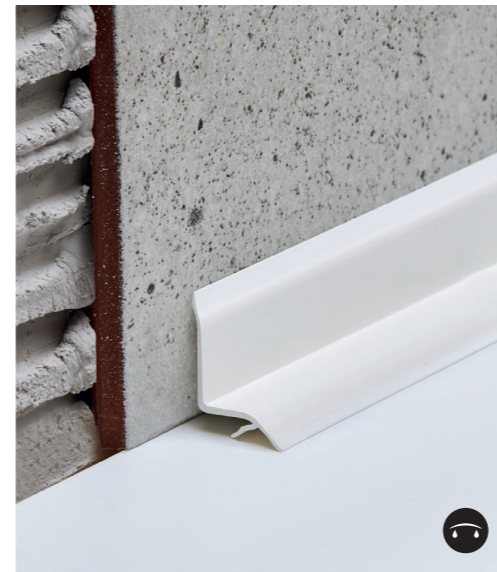

**WNS** PVC  
Self-adhesive bathtub profile

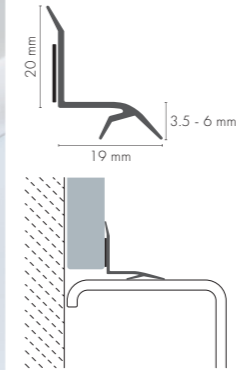

185

185	699634

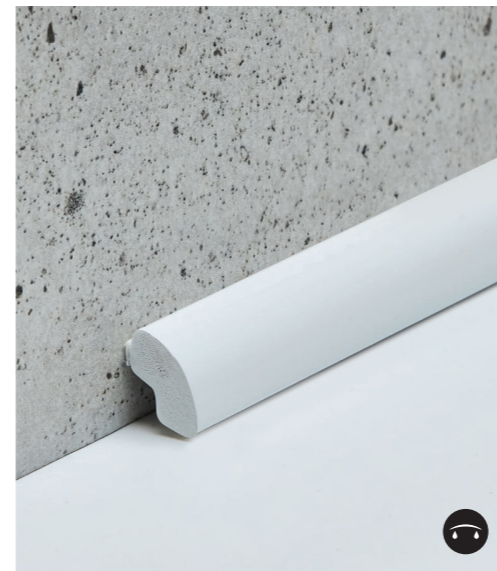

**UO13** PVC  
Oval bathroom seal  $\frac{3}{4}$

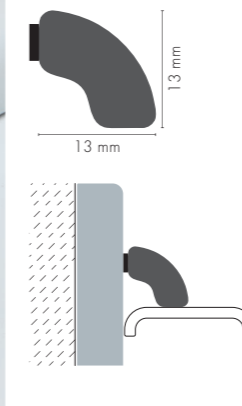

185

185	828720



**WNK** PVC  
Edge profile

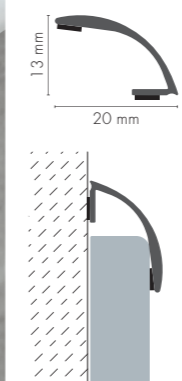

185

185	828737

# BALCONY PROFILES

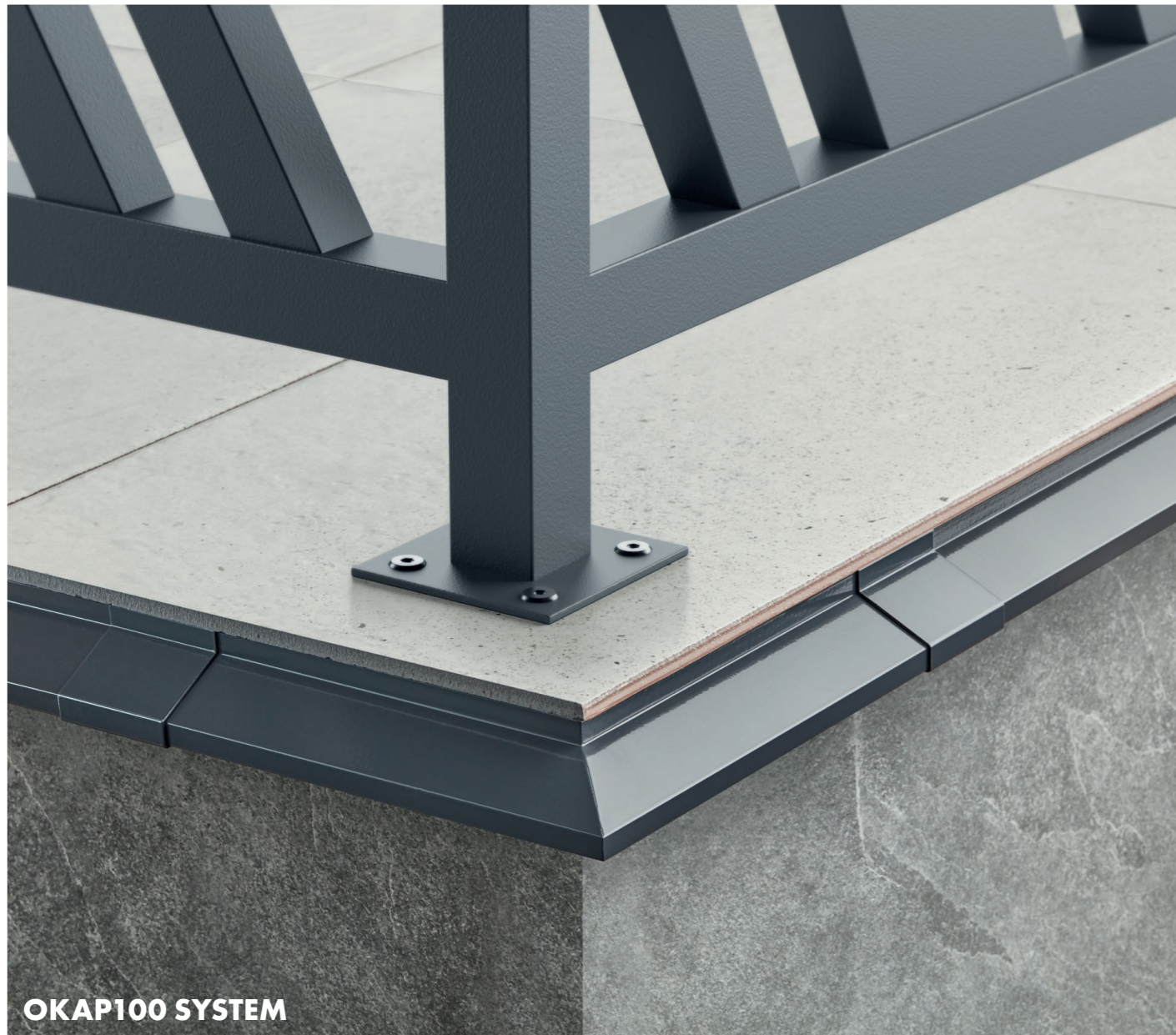

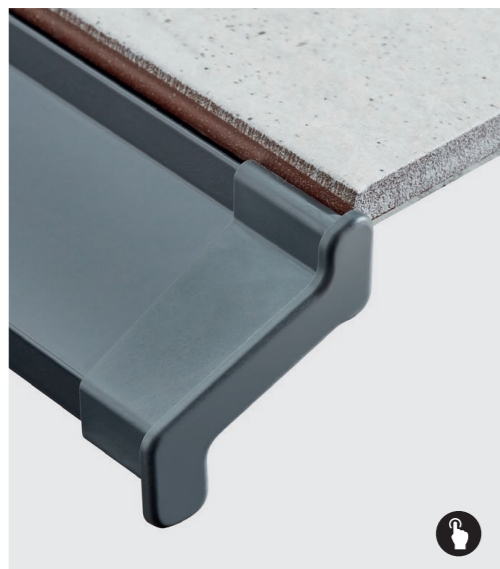

**OKAP100 SYSTEM**



## ZLPOKAP100 PVC

End stops for OKAP100

	
106	827488
123	827471
117	827464

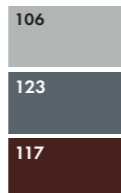

# MULTISPACERS

## Joins 2 tiles



## MULTISPACER I PVC

Accessories for mounting tiles

1/ 1.5/ 2/ 2.5/ 3 mm  
2/ 3/ 4/ 5/ 6 mm **x 2**

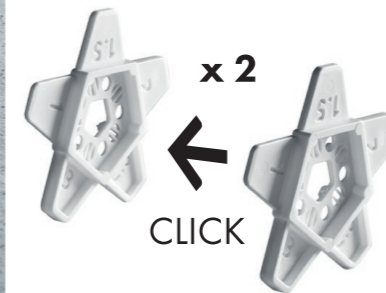

699344

## Joins 3 tiles



## MULTISPACER T PVC

Accessories for mounting tiles

1/ 2/ 3/ 4/ 5 mm



826115

## Joins 4 tiles

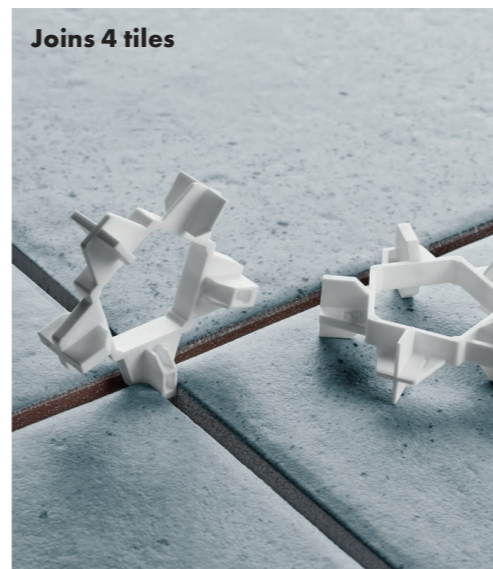

## MULTISPACER X PVC

Accessories for mounting tiles

1/ 2/ 3/ 4/ 5 mm



699382



Our primary product in producing multispacer comes from recycling. The products and the packs are reusable.

## DIY PROFILES PVC

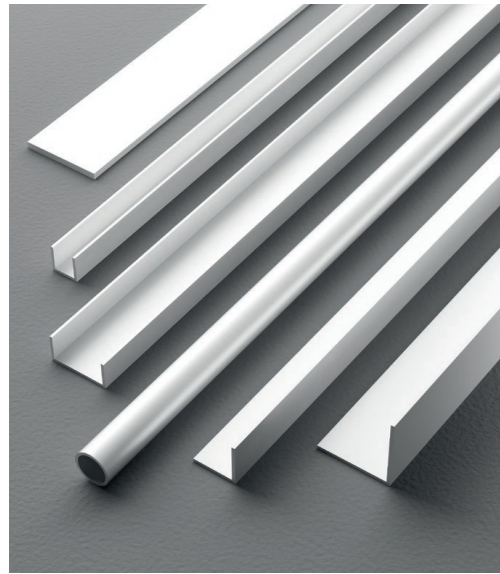

### U-FORM

			A	B	C
101		828270	10	10	1
101		828287	10	10	1
101		828294	12	10	1
101		828300	12	10	1
101		828317	18	10	1
101		828324	18	10	1
101		828331	21	10	1
101		828348	21	10	1



101

### SP (flat bar)

			A	B
101		828249	20	1.5
101		825811	20	1.5
101		825828	20	1.5
101		828256	25	1.5
101		825835	25	1.5
101		828263	30	1.5
101		825842	30	2.5
101		825859	30	2.5



101

### KR (corner)

			A	B	C
101		699399	15	15	1.1
101		699405	20	20	1.1
101		699610	25	25	1.1
101		699627	30	30	1.1



101

### RO (tube)

			A	B
101		828171	7	1
107		828188	7	1
101		828195	10	1
101		828201	10	1
107		828218	10	1
101		828225	12	1
107		828232	12	1



101

107

## FURNITURE PROFILES

### UC16/ UC19 PVC

Waterproof plinth sealing strips

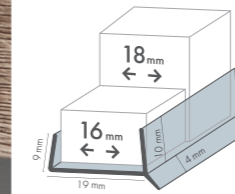

UC16

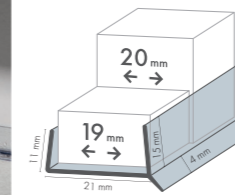

UC19

000  
TRANSPARENT



000



812910

### PP PVC

Guide profiles for furniture

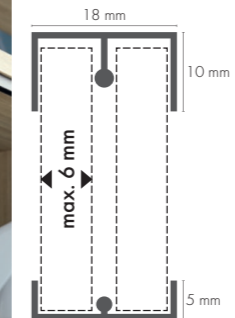

101

107



101



826238

101

829055

101

826245

107

829062

### UZ13 PVC

Reinforced gasket

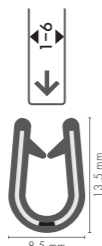
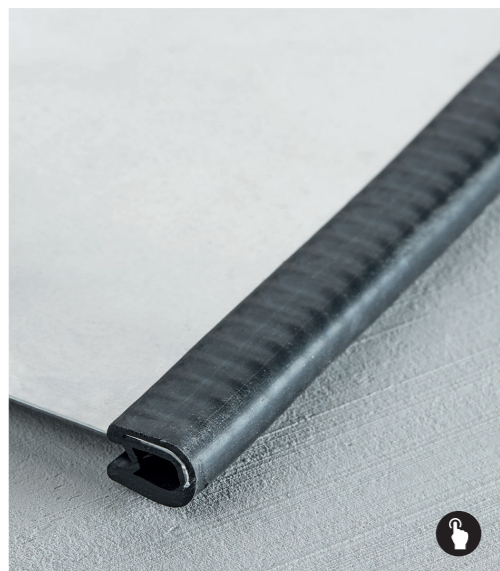

113



113



678615

### PMH PVC

Profile "H" for furniture

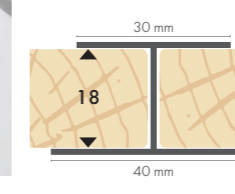
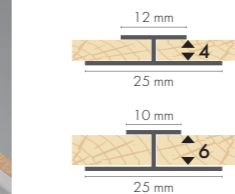

101



101



829079

101

829086

101

829093

# OTHER PRODUCTS



## MOUNTING CLIPS PVC

with spacers

672217	25	36

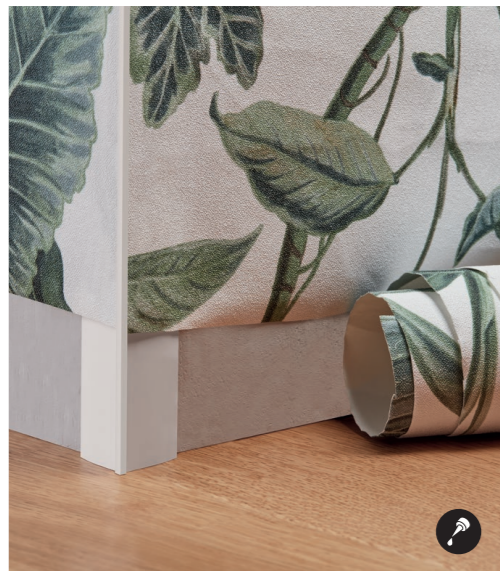
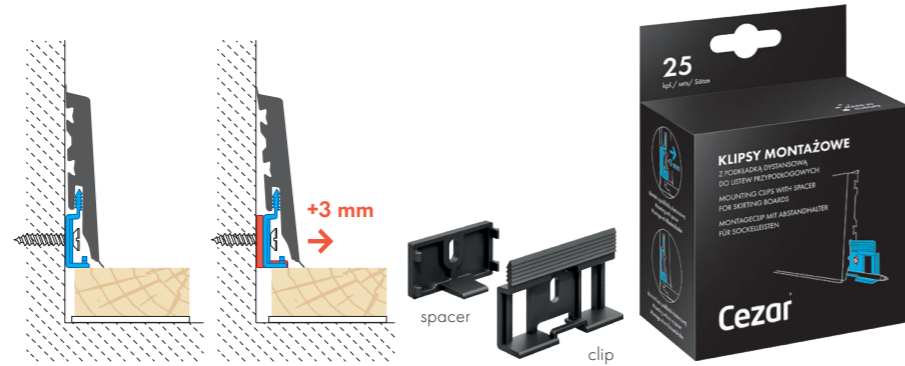

## NT PVC

Wallpaper corner

669668	101

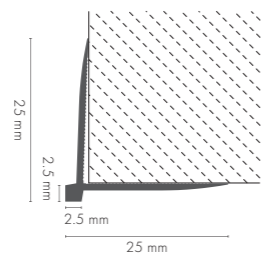

101



## LK-04 XPS

Curtain masking

B101	601880	LK-04	Matt	2.44 m	4
TB101	601897	LK-04	Satin	2.44 m	4

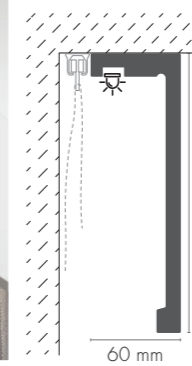

B101  
TB101



## LK-05 XPS

Curtain masking

B101	830488	LK-05	Matt	2.44 m	8



B101  
TB101



## PERSPECTIVE ALU

Self-assembled windows partition

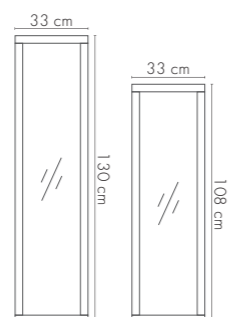

9003

9024

9005



## POLYETHENE FOAM EXPANSION STRIP PE

Laminate in kitchens and bathrooms

837835	15 m	104

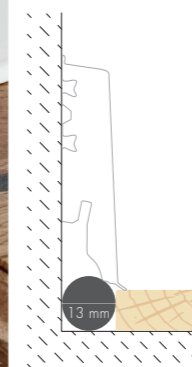



## WE BEGIN REVOLUTION

CEZAR Design Lab conducts research on BIO-compostable material, which is an alternative to PVC profiles and polystyrene or polyethylene accessories.



# bio

products

## PRODUCTS OF THE FUTURE

Using new materials subject to EN 14995 and EN 13432 standards will allow to the production of products that do not harm the natural environment.

We are in the testing phase of products made of a new BIO material: skirting board, accessories and hangers.

Soon we will introduce our clients completely ecological finishing materials.

Compostable bioplastics are biodegradable under environmental safe conditions. This process takes place in certified industrial composting plants.



## CONTROLLED PROCESS

## HOW IT WORKS?

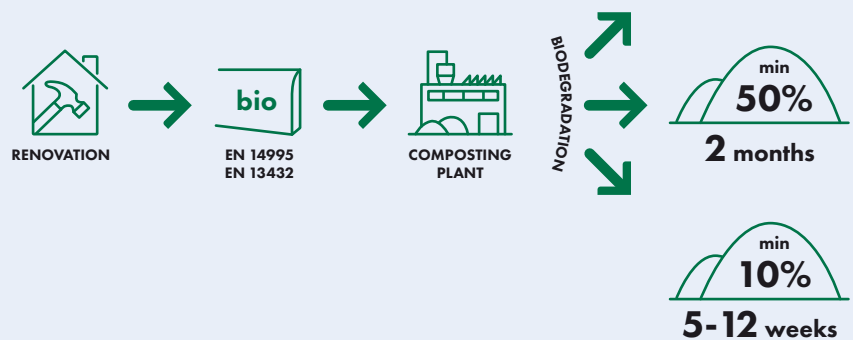

# Cezar

PERFECTION IN DETAILS

ul. Strefowa 2, 19-300 Etk  
tel. +48 87 620 99 00  
tel. +48 87 620 43 20  
cezar@cezar.eu



The information contained in this catalogue is correct to the best of our knowledge and update at the catalogue printing time; therefore the listed data can be altered. The colours and shades shown here are only indicative. No reproduction in whole or in part without prior written permission of the CEZAR. All product names, logos, and brands are property of their respective owners. All company, product and service names used in this catalogue are for informational purposes only. Use of these names, logos, and brands does not imply endorsement. December 2023 edition.